

PLASTIC MEDIUM-POWER COMPLEMENTARY SILICON TRANSISTORS

...designed for general-purpose amplifier and low speed switching applications

FEATURES:

- * Collector-Emitter Sustaining Voltage-
 $V_{CE(SUS)} = 60 \text{ V (Min) - TIP120, TIP125}$
 $= 80 \text{ V (Min) - TIP121, TIP126}$
 $= 100 \text{ V (Min) - TIP122, TIP127}$
- * Collector-Emitter Saturation Voltage
 $V_{CE(sat)} = 2.0 \text{ V (Max.) @ } I_C = 3.0 \text{ A}$
- * Monolithic Construction with Built-in Base-Emitter Shunt Resistor

NPN	PNP
TIP120	TIP125
TIP121	TIP126
TIP122	TIP127

**5.0 AMPERE
DARLINGTON
COMPLEMENTARY SILICON
POWER TRANSISTORS
60-100 VOLTS
65 WATTS**

MAXIMUM RATINGS

Characteristic	Symbol	TIP120 TIP125	TIP121 TIP126	TIP122 TIP127	Unit
Collector-Emitter Voltage	V_{CEO}	60	80	100	V
Collector-Base Voltage	V_{CBO}	60	80	100	V
Emitter-Base Voltage	V_{EBO}	5.0			V
Collector Current-Continuous -Peak	I_C I_{CM}	5.0 8.0			A
Base Current	I_B	120			mA
Total Power Dissipation @ $T_C = 25^\circ\text{C}$ Derate above 25°C	P_D	65 0.52			W W/ $^\circ\text{C}$
Operating and Storage Junction Temperature Range	T_J, T_{STG}	- 65 to +150			$^\circ\text{C}$

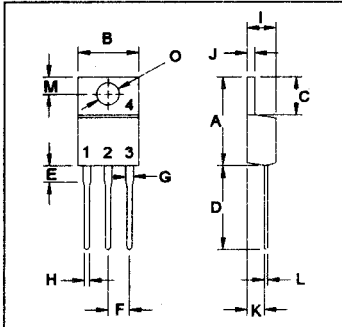
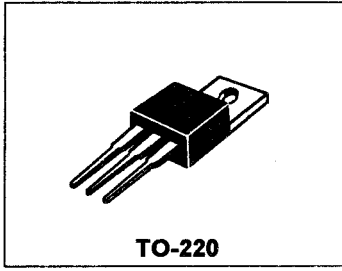

PIN 1.BASE
2.COLLECTOR
3.EMITTER
4.COLLECTOR(CASE)

THERMAL CHARACTERISTICS

Characteristic	Symbol	Max	Unit
Thermal Resistance Junction to Case	$R_{\theta jc}$	1.92	$^\circ\text{C/W}$

DIM	MILLIMETERS	
	MIN	MAX
A	14.68	15.31
B	9.78	10.42
C	5.01	6.52
D	13.06	14.62
E	3.57	4.07
F	2.42	3.66
G	1.12	1.36
H	0.72	0.96
I	4.22	4.98
J	1.14	1.38
K	2.20	2.97
L	0.33	0.55
M	2.48	2.98
O	3.70	3.90

FIGURE -1 POWER DERATING

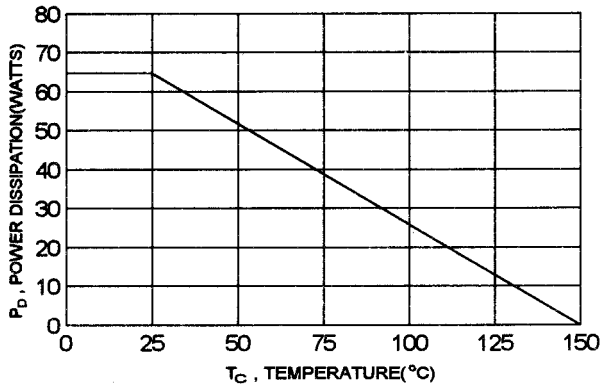

TIP120, TIP121, TIP122 NPN / TIP125, TIP126, TIP127 PNP

ELECTRICAL CHARACTERISTICS ($T_c = 25^\circ\text{C}$ unless otherwise noted)

Characteristic	Symbol	Min	Max	Unit
OFF CHARACTERISTICS				
Collector - Emitter Sustaining Voltage (1) ($I_C = 30\text{ mA}$, $I_B = 0$)	TIP120, TIP125 TIP121, TIP126 TIP122, TIP127	$V_{CE(sus)}$	60 80 100	V
Collector Cutoff Current ($V_{CE} = 30\text{ V}$, $I_B = 0$) ($V_{CE} = 40\text{ V}$, $I_B = 0$) ($V_{CE} = 50\text{ V}$, $I_B = 0$)	TIP120, TIP125 TIP121, TIP126 TIP122, TIP127	I_{CEO}	0.5 0.5 0.5	mA
Collector Cutoff Current ($V_{CB} = 60\text{ V}$, $I_E = 0$) ($V_{CB} = 80\text{ V}$, $I_E = 0$) ($V_{CB} = 100\text{ V}$, $I_E = 0$)	TIP120, TIP125 TIP121, TIP126 TIP122, TIP127	I_{CBO}	0.2 0.2 0.2	mA
Emitter Cutoff Current ($V_{EB} = 5.0\text{ V}$, $I_C = 0$)		I_{EBO}	2.0	mA

ON CHARACTERISTICS (1)

DC Current Gain ($I_C = 0.5\text{ A}$, $V_{CE} = 3.0\text{ V}$) ($I_C = 3.0\text{ A}$, $V_{CE} = 3.0\text{ V}$)	h_{FE}	1000 1000		
Collector-Emitter Saturation Voltage ($I_C = 3.0\text{ A}$, $I_B = 12\text{ mA}$) ($I_C = 5.0\text{ A}$, $I_B = 20\text{ mA}$)	$V_{CE(sat)}$		2.0 4.0	V
Base-Emitter On Voltage ($I_C = 3.0\text{ A}$, $V_{CE} = 3.0\text{ V}$)	$V_{BE(on)}$		2.5	V

DYNAMIC CHARACTERISTICS

Small-Signal Current Gain ($I_C = 3.0\text{ A}$, $V_{CE} = 4.0\text{ V}$, $f = 1.0\text{ MHz}$)	h_{fe}	4.0		
Output Capacitance ($V_{CB} = 10\text{ V}$, $I_E = 0$, $f = 0.1\text{ MHz}$)	TIP120, TIP121, TIP122 TIP125, TIP126, TIP127	C_{ob}	300 250	pF

(1) Pulse Test: Pulse width = 300 us , Duty Cycle $\leq 2.0\%$

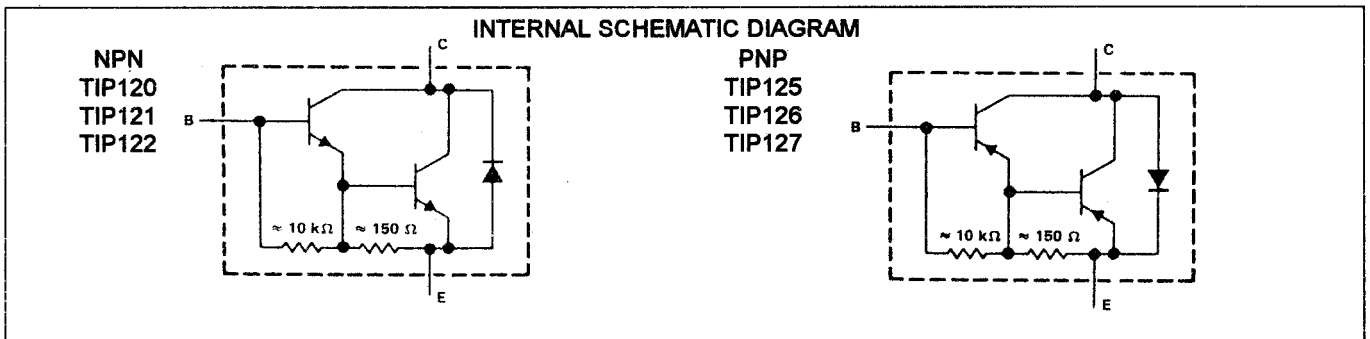

FIG-2 SWITCHING TIME

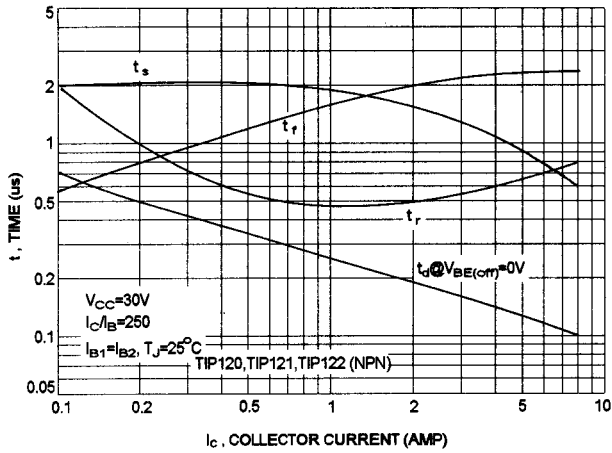

FIG-3 SWITCHING TIME

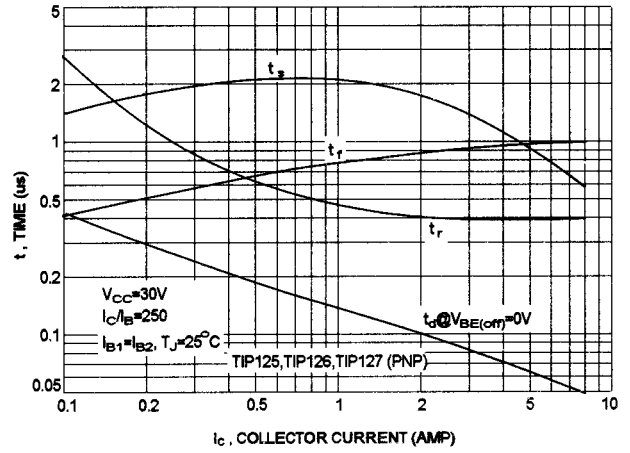

FIG-4 SMALL-SIGNAL CURRENT GAIN

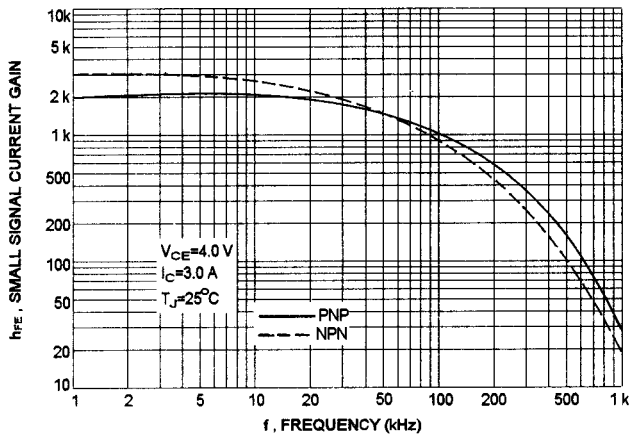

FIG-5 CAPACITANCES

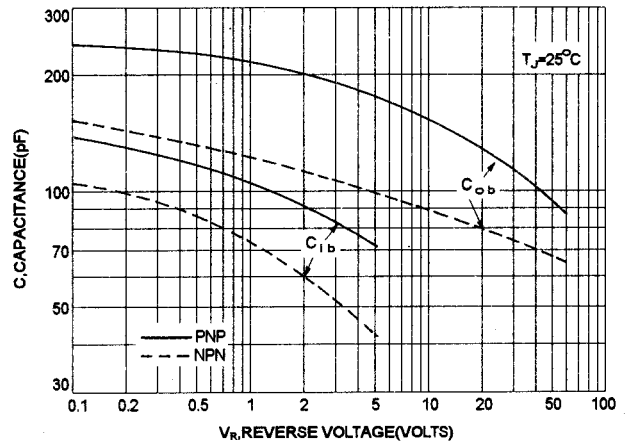
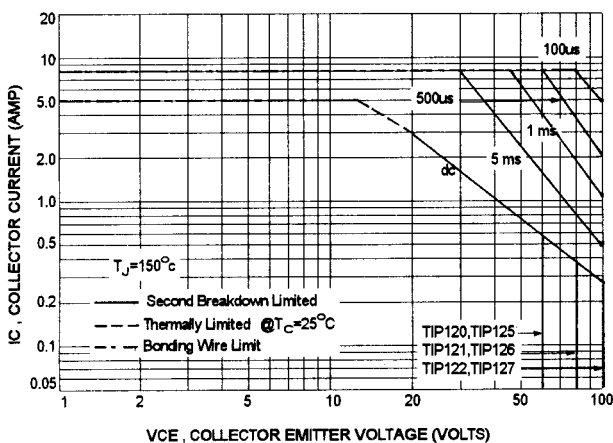

FIG-6 ACTIVE REGION SAFE OPERATING AREA



There are two limitation on the power handling ability of a transistor: average junction temperature and second breakdown safe operating area curves indicate I_C - V_{CE} limits of the transistor that must be observed for reliable operation i.e., the transistor must not be subjected to greater dissipation than curves indicate.

The data of FIG-6 is base on $T_{J(PK)}=150^\circ C$, T_C is variable depending on power level. second breakdown pulse limits are valid for duty cycles to 10% provided $T_{J(PK)} \leq 150^\circ C$. At high case temperatures, thermal limitation will reduce the power that can be handled to values less than the limitations imposed by second breakdown.

TIP120, TIP121, TIP122 NPN / TIP125, TIP126 TIP127 PNP

NPN TIP120,TIP121,TIP122

PNP TIP125,TIP126,TIP127

FIG-7 DC CURRENT GAIN

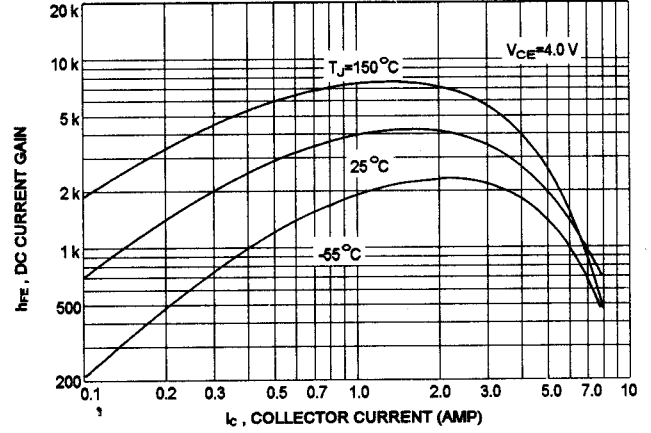
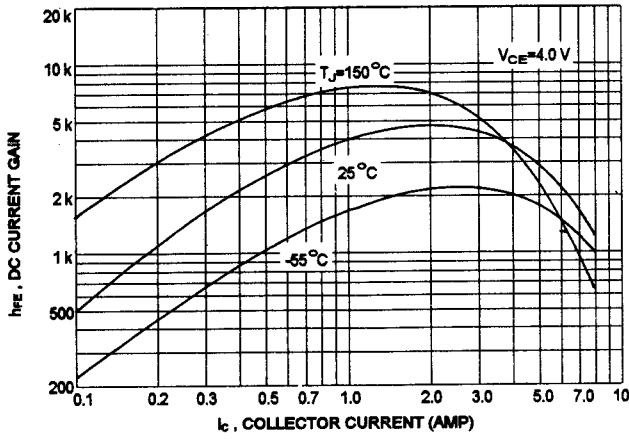

FIG-8 COLLECTOR SATURATION REGION

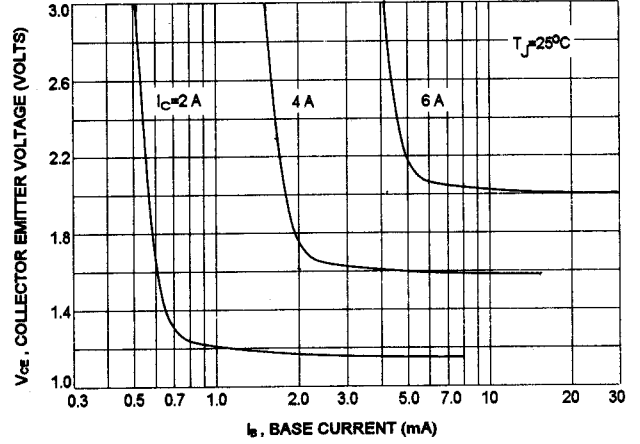
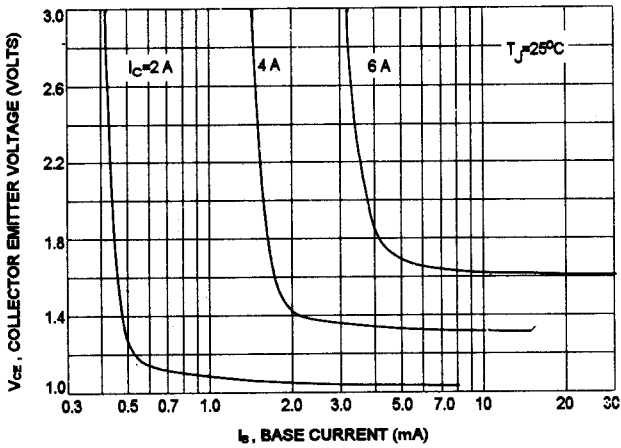

FIG-9 "ON" VOLTAGES

